

EI0279BS/EI1279BS

TERMINALI + CONNETTORI

Terminali

Materiale: Ottone stagnato

Utilizzabili nelle Serie EH7619 e E8991, 2.36mm

Estrattore ER785



CODICE	SEZ. FILO	MATERIALE	SPESS.	FINITURA	A	B	C	D	DIAM. ISOLANTE	Q.TÀ PER BOBINA
EI0279BS-WST	AWG 18 - 22	Ottone	0,25	Stagnato	3,70	3,60	2,90	3,30	2,50	4,000pz
EI1279BS-WST	AWG 18 - 22	Ottone	0,25	Stagnato	3,70	3,60	2,90	3,30	2,50	4,000pz
EI0279BS-2A	AWG 14 - 20	Ottone	0,25	Stagnato	3,70	3,60	2,90	3,30	2,50	4,000pz
EI1279BS-2A	AWG 14 - 20	Ottone	0,25	Stagnato	3,70	3,60 <td 2,90	3,30	2,50	4,000pz	

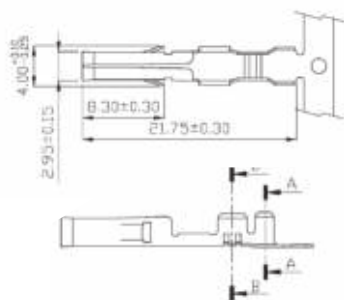

EI1279BS-2

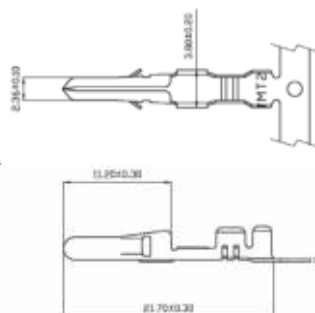
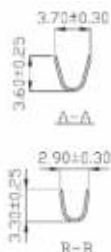

EI0279BS-2

EH7619

TERMINALI + CONNETTORI

Connettore standard passo 2.36 mm

Materiale: Nylon UL 94V-2

Possibilità di fissaggio con alette integrate

Richiede terminali maschi e femmine serie EI0279 e EI1279



N° di Vie	DIMENSIONI	
1	<p>EH7619PI-01 (Senza Alette)</p>	<p>EH7619RI-01 (Senza Alette)</p>

EH7619

TERMINALI + CONNETTORI

Connettori
standard passo 2.36 mm

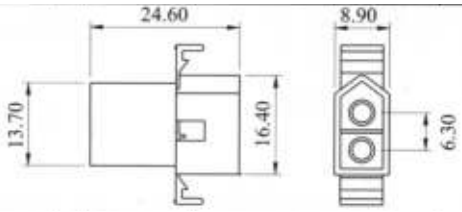
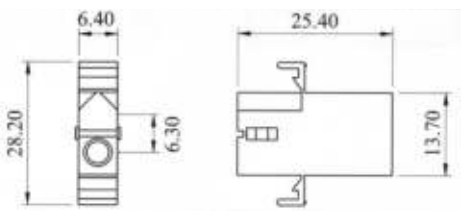
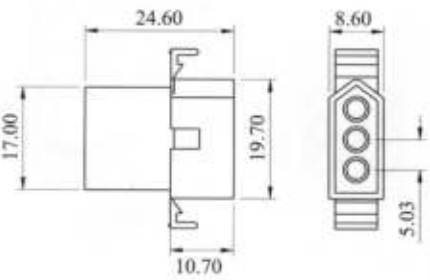
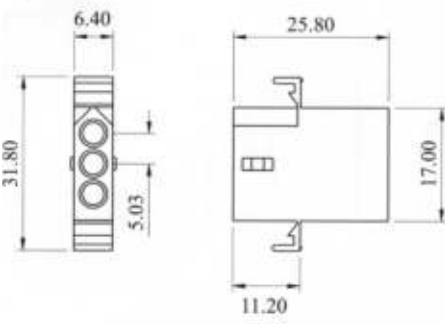
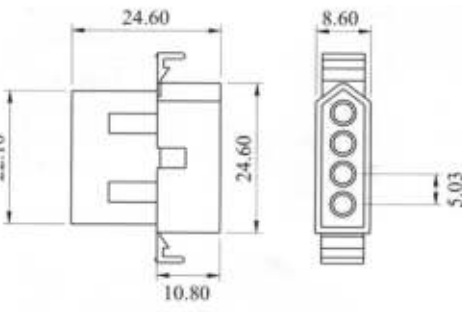
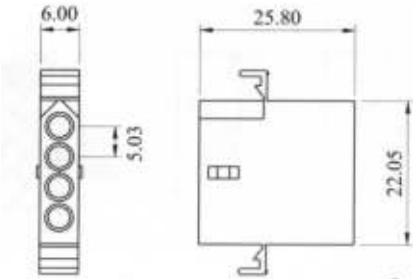

N° di Vie	DIMENSIONI	
2	 <p>EH7619P - 02 (Con alette) EH7619PI - 02 (Senza Alette)</p>	 <p>EH7619R - 02 (Con alette) EH7619RI - 02 (Senza Alette)</p>
3	 <p>EH7619P - 03 (Con alette) EH7619PI - 03 (Senza Alette)</p>	 <p>EH7619R - 03 (Con alette) EH7619RI - 03 (Senza Alette)</p>
4	 <p>EH7619P - 04 (Con alette) EH7619PI - 04 (Senza Alette)</p>	 <p>EH7619R - 04 (Con alette) EH7619RI - 04 (Senza Alette)</p>

EH7619

TERMINALI + CONNETTORI

Connettori

standard passo 2.36 mm

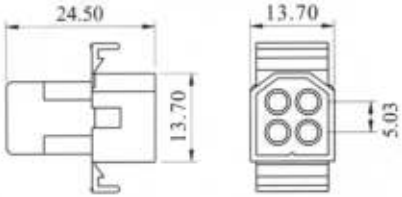
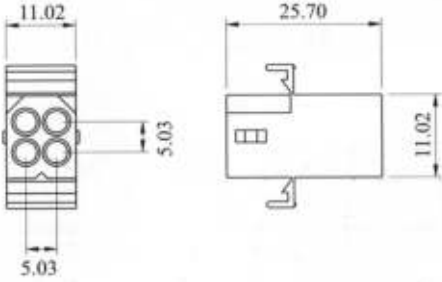
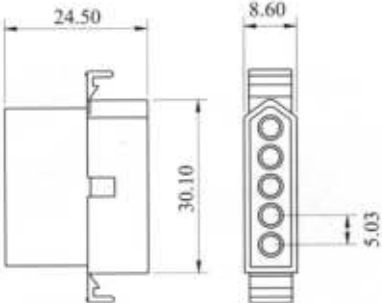
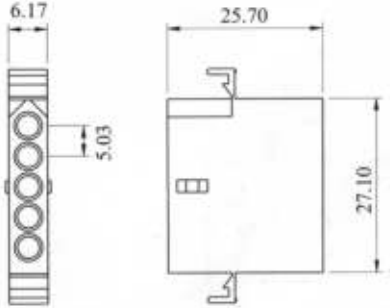
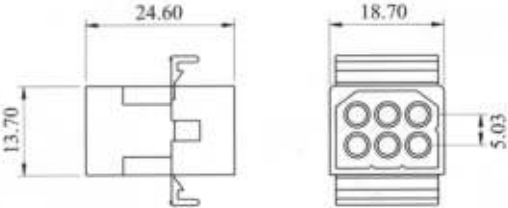
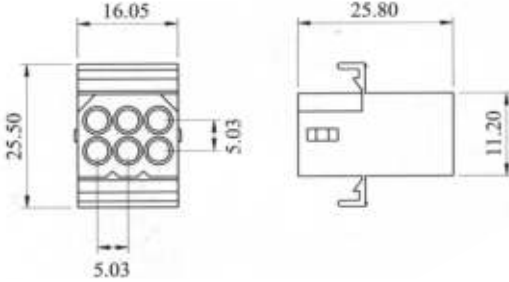

N° di Vie	DIMENSIONI	
2x2	 <p>EH7619P - 2x2 (Con alette) EH7619PI - 2x2 (Senza Alette)</p>	 <p>EH7619R - 2x2 (Con alette) EH7619RI - 2x2 (Senza Alette)</p>
5	 <p>EH7619P - 05 (Con alette) EH7619PI - 05 (Senza Alette)</p>	 <p>EH7619R - 05 (Con alette) EH7619RI - 05 (Senza Alette)</p>
6	 <p>EH7619P - 06 (Con alette) EH7619PI - 06 (Senza Alette)</p>	 <p>EH7619R - 06 (Con alette) EH7619RI - 06 (Senza Alette)</p>

EH7619

TERMINALI + CONNETTORI

Connettori
standard 2.36 mm



N° di Vie	DIMENSIONI			
9	<p>EH7619P - 09 (Con alette) EH7619PI - 09 (Senza Alette)</p>		<p>EH7619R - 09 (Con alette) EH7619RI - 09 (Senza Alette)</p>	
12	<p>EH7619P - 12 (Con alette) EH7619PI - 12 (Senza Alette)</p>		<p>EH7619R - 12 (Con alette) EH7619RI - 12 (Senza Alette)</p>	
15	<p>EH7619P - 15 (Con alette) EH7619PI - 15 (Senza Alette)</p>		<p>EH7619R - 15 (Con alette) EH7619RI - 15 (Senza Alette)</p>	



E899 I

TERMINALI + CONNETTORI

Connettore

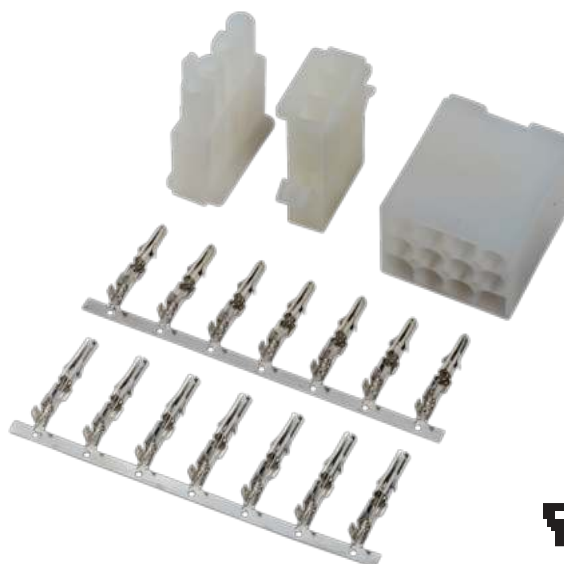
- Materiale: Nylon UL 94V-2 o UL 94V-0 (a richiesta)
- Polarizzazione integrata
- Possibilità di fissaggio con alette integrate
- Aggancio di sicurezza
- Utilizza i terminali Serie EI0279 / EI1279

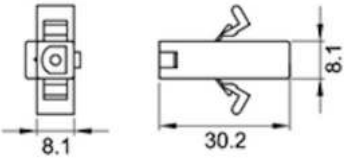

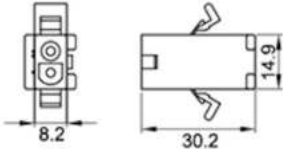
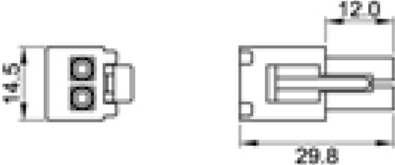
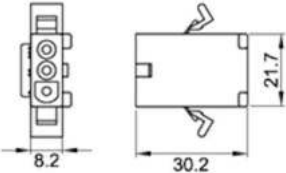
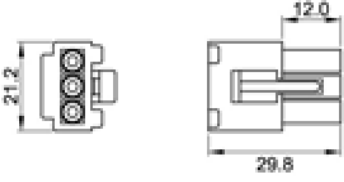
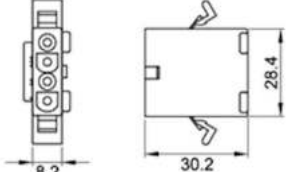
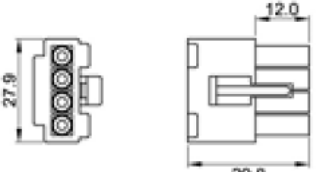
N° di Vie	DIMENSIONI	
1	 <p>E899I-01PI (Senza Alette)</p>	 <p>E899I-01RI</p>
2	 <p>E899I-02P (Con alette) E899I-02PI (Senza Alette)</p>	 <p>E899I-02RI</p>
3	 <p>E899I-03P (Con alette) E899I-03PI (Senza Alette)</p>	 <p>E899I-03RI</p>
4	 <p>E899I-04P (Con alette) E899I-04PI (Senza Alette)</p>	 <p>E899I-04RI</p>

E899 I

TERMINALI + CONNETTORI

Connettore

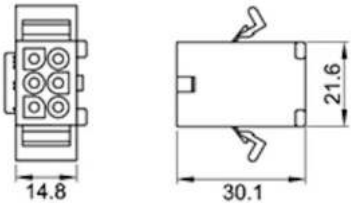
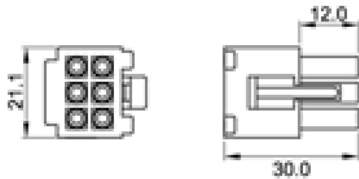
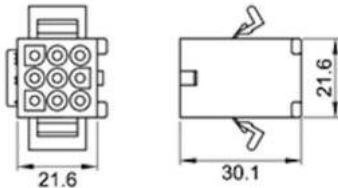
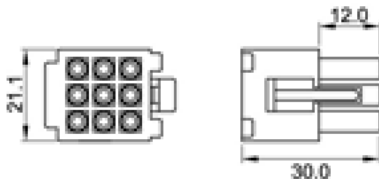
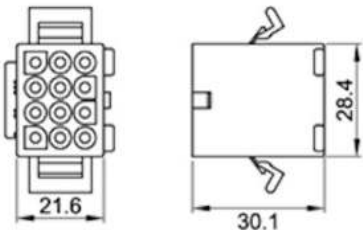
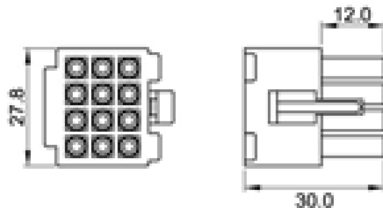
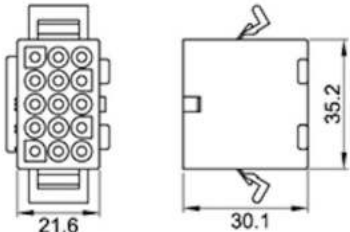
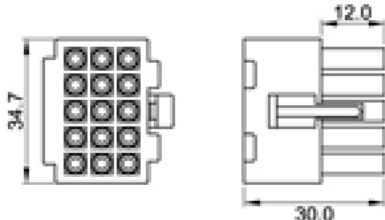

N° di Vie	DIMENSIONI	
6	 <p>E899I-06P (Con alette) E899I-06PI (Senza Alette)</p>	 <p>E899I-06RI</p>
9	 <p>E899I-09P (Con alette) E899I-09PI (Senza Alette)</p>	 <p>E899I-09RI</p>
12	 <p>E899I-12P (Con alette) E899I-12PI (Senza Alette)</p>	 <p>E899I-12RI</p>
15	 <p>E899I-15P (Con alette) E899I-15PI (Senza Alette)</p>	 <p>E899I-15RI</p>